

DÉPOSITOS Y ACCESORIOS. FILTROS, CAMPANAS Y ACOPLAMIENTOS

TANKS AND ACCESSORIES FILTERS, BELLHOUSINGS AND COUPLINGS

RESERVOIRS ET ACCESSOIRES. FILTRES, LANTERNES ET ACCOUPLEMENTS

- Depósitos y Accesorios

Tanks and Accessories

Réservoirs et Accessoires9

- Filtros

Filters

Filtres16

- Campanas y Acoplamientos

Bellhousings and Couplings

Lanternes et Accouplements20

DEPÓSITOS HIDRÁULICOS
OIL TANKS
RÉSERVOIR D'HUILE

Depósitos tipo CF, acero

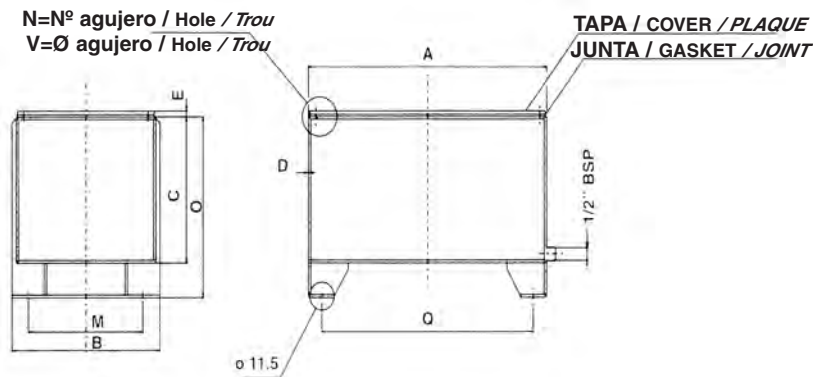

Oil tanks type CF, steel

Reservoirs type CF, acier

REFERENCIA PART NO. RÉFÉRENCE	CAPACIDAD FLOW CAPACITÉ litros/liters/litres	DIMENSIONES DIMENSIONS DIMENSIONS								TAPA COVER PLAQUE		€
		A	B	C	D	E	M	O	Q	N	V	
CF12GC	14	335	270	235	2	4	208	290	285	6	M8	-
CF16GC	22	410	325	250	2	4	270	305	364	6	M8	-
CF30GC	39	470	375	280	2	4	312	335	428	8	M8	259,04
CF55GC	58	600	470	310	2,5	4	401	365	548	10	M8	343,23
CF75GC	75	600	470	400	2,5	4	401	455	548	10	M8	369,22
CF100GC	100	675	520	450	2,5	4	455	505	625	10	M8	478,86
CF180GC	165	805	620	500	2,5	4	555	555	755	10	M8	-

OTROS DEPÓSITOS
OTHER OIL TANKS
RÉSERVOIR D'HUILE

- **ACERO, EQUIPADOS** / STEEL WITH ACCESSORIES / *ACIER, AVEC ACCESSOIRES*

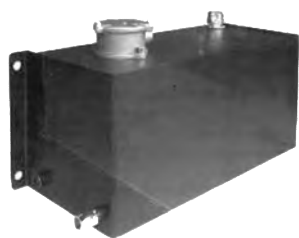

- **ACERO** / STEEL / *ACIER*

- **ALUMINIO** / ALUMINIUM / *ALUMINIUM*

- **ALUMINIO, EQUIPADO**
ALUMINIUM, WITH
ACCESSORIES /
ALUMINIUM AVEC ACCESSOIRES

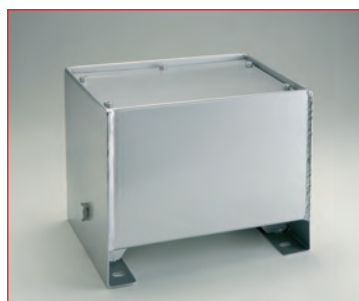

DEPÓSITOS HIDRÁULICOS
OIL TANKS
RÉSERVOIR D'HUILE

Depósitos tipo CFP, acero
(para montar con tapas de registro)

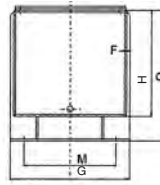

N=Nº agujero / Hole / Trou
V=Ø agujero / Hole / Trou

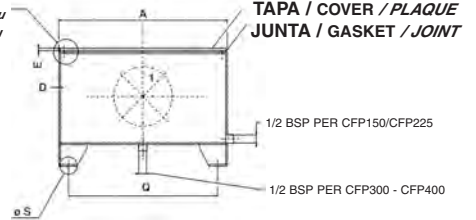

Oil tanks type CFP, steel (for mounting inspection cover)

Reservoirs type CFP, acier (pour monter avec plaque d'inspection)

REFERENCIA PART NO. RÉFÉRENCE	DIMENSIONES DIMENSIONS DIMENSIONS										Nº AGUJEROS Nº HOLES Nº TROUS	€
	A	B	O	C	D	F	E	S	M	Q		
CFP150	750	500	600	545	4	4	6	11,5	410	690	4	733,57
CFP225	900	600	640	585	4	4	6	11,5	510	820	4	955,89
CFP300	900	700	700	600	4	4	8	14	610	820	6	1259,27
CFP400	1260	765	720	620	5	4	8	14	650	1160	6	1921,25

Tapas de Registro



Inspection Covers

Plaques d'inspection

REFERENCIA PART NO. RÉFÉRENCE	DIMENSIONES DIMENSIONS DIMENSIONS					Nº AGUJEROS Nº HOLES Nº TROUS	€
	A	B	H	C	D		
TRD 275	275	23	12	255	200	6	42,64
TRD 350	350	-	18,5	324	258	4	67,18
TRD 400	400	23	12	380	325	8	62,06
TRD 475	475	-	15,5	449	382	6	97,26

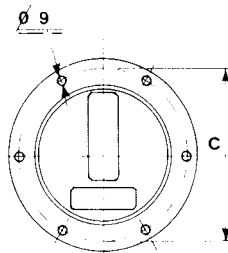

TRD 275

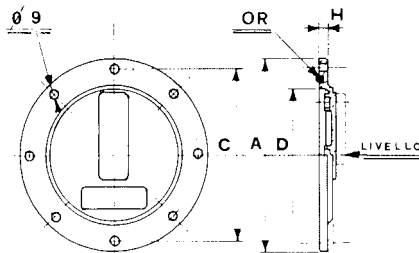

TRD 400

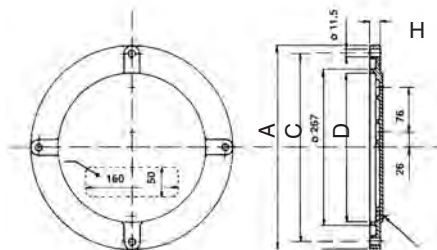

TRD 350

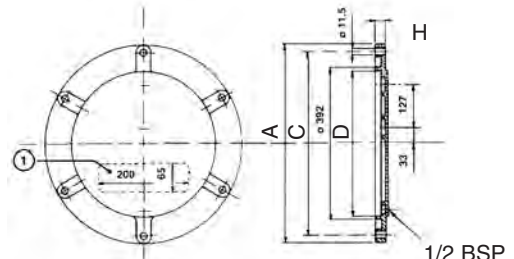



TRD 475

1/2 BSP

DEPÓSITOS
BOMBAS Y DIVISORES
MOTORES ELÉCTRICOS
VÁLVULAS
DISTRIBUIDORES
ELECTROVÁLVULAS
EMPUÑADURAS
ACUMULADORES
CILINDROS
VARIOS

	Niveles cromados		
	<i>Chromed levels</i>		
	<i>Niveaux passés au bichromate de potasse</i>		
	REFERENCIA PART NO. RÉFÉRENCE	DESCRIPCION DESCRIPTION DESCRIPTION	€
	CON TERMÓMETRO / WITH THERMOMETER / AVEC THERMOMÈTRE		
LG1T	76 mm	17,99	
LG2T	127 mm	23,35	

	Niveles de plástico		
	<i>Levels Plastic</i>		
	<i>Niveaux en plastique</i>		
	REFERENCIA PART NO. RÉFÉRENCE	DESCRIPCION DESCRIPTION DESCRIPTION	€
	SIN TERMÓMETRO / WITHOUT THERMOMETER / SANS THERMOMÈTRE		
LT1	76 mm	13,86	
LT2	127 mm	16,03	
CON TERMÓMETRO / WITH THERMOMETER / AVEC THERMOMÈTRE			
LT1T	76 mm	15,09	
LT2T	127 mm	17,29	

	Tapón llenado plástico		
	<i>Filler cork plastic</i>		
	<i>Bouchon Plastique de Remplissage</i>		
	REFERENCIA PART NO. RÉFÉRENCE	DESCRIPCION DESCRIPTION DESCRIPTION	€
TPA	-	14,14	

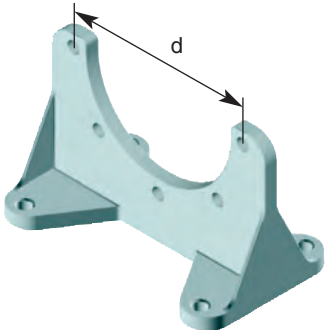
	Brida Acople Motor			
	<i>Foot flange</i>			
	<i>Bride d'accouplement moteur</i>			
	REFERENCIA PART NO. RÉFÉRENCE	DESCRIPCION DESCRIPTION DESCRIPTION	d	€
	P160	Para brida	160mm.	27,36
P200	Para brida	200mm.	34,87	
P250	Para brida	250mm.	57,56	
P300	Para brida	300mm.	77,53	

DEPÓSITOS Y ACCESORIOS
TANKS AND ACCESSORIES
RÉSERVOIR ET ACCESSOIRES

	Tapones de Llenado		
	<i>Filler Breather</i>		
	<i>Bouchon de Remplissage</i>		
	REFERENCIA PART NO. RÉFÉRENCE	DESCRIPCION DESCRIPTION DESCRIPTION	€
	FT-5-C10 FT-8-C10/1 FT-8-C10/2	MINI 10 μ NORMAL 10 μ LARGO 10 μ	13,23 15,74 17,64
FT-5-C40 FT-8-C40/1 FT-8-C40/2	MINI 40 μ NORMAL 40 μ LARGO 40 μ	11,73 13,02 15,55	

	Tapón Acero sin Filtro		
	<i>Filler Breather without Filter</i>		
	<i>Bouchon Acier sans Filtre</i>		
	REFERENCIA PART NO. RÉFÉRENCE	ROSCA THREAD FILETAGE	€
	TSFO/R0G TSFO/R1G TSFO/R2G TSFO/R3G TSFO/R4G TSFO/R5G	1/8 BSP 1/4 BSP 3/8 BSP 1/2 BSP 3/4 BSP 1 BSP	2,36 2,51 2,66 3,53 4,91 7,55

	Tapón Acero con Filtro en la Base		
	<i>Filler Breather with Filter in the Base</i>		
	<i>Bouchon Acier Reniflard Vissable Filtre au Fond</i>		
	REFERENCIA PART NO. RÉFÉRENCE	ROSCA THREAD FILETAGE	€
	TSF1G TSF2G TSF3G TSF4G TSF5G TSF6G TSF7G TSF8G	1/4 BSP 3/8 BSP 1/2 BSP 3/4 BSP 1 BSP 1 1/4 BSP 1 1/2 BSP 2 BSP	3,50 4,26 5,14 7,08 10,07 16,87 22,97 42,64

	Tapón Acero con Filtro en Cabeza		
	<i>Filler Breather with Filter in the Head</i>		
	<i>Bouchon Acier Reniflard Vissable avec Filtre en la Tête</i>		
	REFERENCIA PART NO. RÉFÉRENCE	ROSCA THREAD FILETAGE	€
	TSFA0G TSFA1G TSFA2G TSFA3G TSFA4G TSFA5G	1/8 BSP 1/4 BSP 3/8 BSP 1/2 BSP 3/4 BSP 1 BSP	2,85 2,92 3,67 4,59 6,39 9,77



Tapón Hexagonal Metálico con Agujero y con Filtro		
<i>Metallic Hexagonal Plug with Hole and Filter</i>		
<i>Bouchon Acier Reniflard Vissable avec Purge et Filtre</i>		
REFERENCIA PART NO. RÉFÉRENCE	ROSCA THREAD FILETAGE	€
TCSF1G	1/4 BSP	2,48
TCSF2G	3/8 BSP	2,87
TCSF3G	1/2 BSP	4,11
TCSF4G	3/4 BSP	5,31
TCSF5G	1 BSP	7,53



Tapón Macho Hexagonal		
<i>Hexagonal Male Plug</i>		
<i>Bouchon Mâle Hexagonal</i>		
REFERENCIA PART NO. RÉFÉRENCE	ROSCA THREAD FILETAGE	€
TC/F1G	1/4 BSP	1,43
TC/F2G	3/8 BSP	1,65
TC/F3G	1/2 BSP	2,16
TC/F4G	3/4 BSP	3,68
TC/F5G	1 BSP	4,71



Tapón Magnético		
<i>Magnetic Plug</i>		
<i>Bouchon Acier Vissable Magnétique</i>		
REFERENCIA PART NO. RÉFÉRENCE	ROSCA THREAD FILETAGE	€
HEXAGONAL		
TCSM/F1G	1/4 BSP	3,75
TCSM/F2G	3/8 BSP	4,26
TCSM/F3G	1/2 BSP	6,06
TCSM/F4G	3/4 BSP	8,06
TCSM/F5G	1 BSP	11,29
ALLEN		
TCEM 1G	1/4 BSP	2,80
TCEM 2G	3/8 BSP	2,92
TCEM 3G	1/2 BSP	3,68
TCEM 4G	3/4 BSP	6,66
TCEM 5G	1 BSP	7,66
TCEM 6G	1 1/4 BSP	14,98
TCEM 7G	1 1/2 BSP	19,94





Tapón Desvaporador		
<i>Disvaporized Plug</i>		
<i>Bouchon Reniflard Vissable</i>		
REFERENCIA PART NO. RÉFÉRENCE	ROSCA THREAD FILETAGE	€
FAI4	1/4 BSP	9,74
FAI6	3/8 BSP	10,12
FAI8	1/2 BSP	10,86
FAI12	3/4 BSP	14,43
FAI16	1 BSP	20,53

DEPÓSITOS Y ACCESORIOS
TANKS AND ACCESSORIES
RÉSERVOIR ET ACCESSOIRES

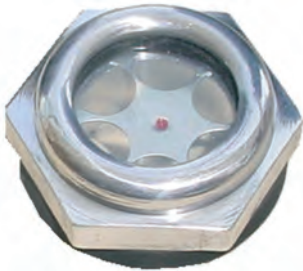
	Niveles			
	<i>Level Gauges</i>			
	<i>Indicateurs de Niveau</i>			
	REFERENCIA PART NO. RÉFÉRENCE	METRICA METRIC METRIQUE	DESCRIPCION DESCRIPTION DESCRIPTION	€
	SIN TERMÓMETRO/ WITHOUT THERMOMETER/SANS THERMOMÈTRE			
	FL-1	M10	76 mm	15,06
	FL-2	M12	127 mm	18,15
FL-3	M12	254 mm	23,95	
CON TERMÓMETRO/ WITH THERMOMETER/AVEC THERMOMÈTRE				
FL-1T	M10	76 mm	16,42	
FL-2T	M12	127 mm	20,47	
FL-3T	M12	254 mm	25,34	

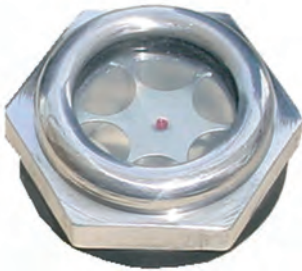
	Visor Aluminio (BSP)		
	<i>BSP Aluminium Sight</i>		
	<i>Voyant de Niveau Aluminium Gaz</i>		
	REFERENCIA PART NO. RÉFÉRENCE	ROSCA THREAD FILETAGE	€
	TLA1G	1/4 BSP	2,59
	TLA2G	3/8 BSP	2,77
	TLA3G	1/2 BSP	3,10
TLA4G	3/4 BSP	3,68	
TLA5G	1 BSP	5,24	
TLA6G	1 1/4 BSP	10,43	
TLA7G	1 1/2 BSP	12,18	
TLA8G	2 BSP	23,35	

	Visor Aluminio Métrico		
	<i>Metric Aluminium Sight</i>		
	<i>Voyant de Niveau Aluminium Métrique</i>		
	REFERENCIA PART NO. RÉFÉRENCE	ROSCA THREAD FILETAGE	€
	TLA1M	M14X1,5	2,59
	TLA2M	M16X1,5	2,77
	TLA5M	M22X1,5	3,10
TLA6M	M24X1,5	4,64	
TLA9M	M27X1,5	4,89	
TLA10M	M30X1,5	5,10	
TLA12M	M33X1,5	5,24	

	Visor Lateral Acrílico		
	<i>Acrylic Lateral Visual Level</i>		
	<i>Voyant de Niveau Latéral Acrilique</i>		
	REFERENCIA PART NO. RÉFÉRENCE	ROSCA THREAD FILETAGE	€
	1FC1G	1/2 BSP	3,10
	1FC2G	3/4 BSP	3,68
	1FC3G	1 BSP	5,24
1FC4G	1 1/4 BSP	11,66	

	Brida Inclinada para Tapón 1" Gas		
	<i>Inclined Flange for BSP Plug 1"</i>		
	<i>Embase Inclinée pour Bouchon de Remplissage</i>		
	REFERENCIA PART NO. RÉFÉRENCE	ROSCA THREAD FILETAGE	€
FLGV5G	1 BSP	13,40	

	Brida Inclinada con Tapón de Llenado		
	<i>Inclined Flange with Breather</i>		
	<i>Embase Inclinée avec Bouchon de Remplissage</i>		
	REFERENCIA PART NO. RÉFÉRENCE	μ	€
TCARI 1080	10 μ	41,72	
TCARI 4080	40 μ	39,53	

	Nivel Eléctrico 1 Contacto Mínima N.C.		
	<i>Electrical Level Gauge 1 Contact Min. NC</i>		
	<i>Niveau Électrique 1 Contact</i>		
	REFERENCIA PART NO. RÉFÉRENCE	LONGITUD VARILLA LENGHT LONGUEUR	€
	NE1C 150	150 mm	98,87
	NE1C 200	200 mm	98,87
	NE1C 250	250 mm	98,87
	NE1C 300	300 mm	98,87
NE1C 350	350 mm	98,87	
NE1C 400	400 mm	103,94	
NE1C 450	450 mm	103,94	
NE1C 500	500 mm	103,94	

	Nivel Eléctrico 2 Contactos Máxima-Mínima N.C.		
	<i>Electrical Level Gauge 2 Contact Max-Min. NC</i>		
	<i>Niveau Électrique 2 Contacts</i>		
	REFERENCIA PART NO. RÉFÉRENCE	LONGITUD VARILLA LENGHT LONGUEUR	€
	NE2C 200	200 mm	308,05
	NE2C 250	250 mm	311,19
	NE2C 300	300 mm	314,24
	NE2C 350	350 mm	317,26
NE2C 400	400 mm	348,26	
NE2C 500	500 mm	356,19	

FILTRO ASPIRACIÓN

FILTERS
FILTRES

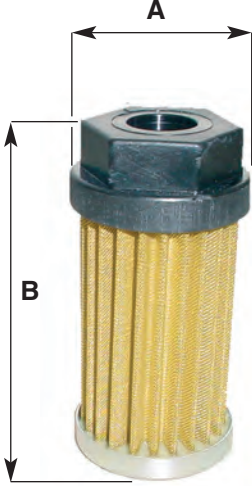
	Filtro Aspiración 125 Micras					
	<i>Suction Filters</i>					
	<i>Crepines d'aspiration 125 µ</i>					
	REFERENCIA PART NO. RÉFÉRENCE	A	B	CAUDAL FLOW DEBIT l/min	ROSCA THREAD FILETAGE	€
FS-1-10-T125	46	90	15	3/8	14,87	
FS-1-11-T125	46	105	35	1/2	15,10	
FS-1-20-T125	64	109	52	3/4	17,23	
FS-1-21-T125	64	139	100	1	18,00	
FS-1-30-T125	86	139	125	1	22,02	
FS-1-31-T125	86	139	160	1 1/4	21,51	
FS-1-32-T125	86	139	180	1 1/2	21,51	
FS-1-33-T125	86	200	215	1 1/2	23,99	
FS-1-34-T125	86	260	280	2	26,77	
FS-1-40-T125	150	151	230	1 1/2	36,73	
FS-1-41-T125	150	151	270	2	35,46	
FS-1-42-T125	150	211	500	2 1/2	40,75	
FS-1-43-T125	150	272	500	3	45,31	

Para otro micrage consútenos (ejemplo 250 micras para fuel-oil o gasoil).

For any other size, please, enquire us (ex. 250 µ for fuel-oil or gaz-oil)

Pour d'autre type de micron, demandez-nous (exemple 250 microns pour fuel-oil ou gas-oil)

FILTROS DE PRESIÓN EN LÍNEA. PRESIÓN MÁXIMA 420 BAR

LINE PRESSURE FILTER. PRESSION MAX.: 420 BAR.
FILTRE DE PRESSION EN LIGNE. PRESSION MAX.: 420 BAR.

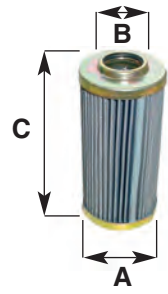
Filtro Completo con Cartucho y Visor Óptico 				Cartucho 						
<i>Line pressure Filter (Complete)</i>				<i>Line Pressure Filter (Cartridge)</i>						
<i>Filtre Haute Pression Complet avec Voyant Optique</i>				<i>Cartouche Filtre Haute Pression</i>						
REFERENCIA PART NO. RÉFÉRENCE	ROSCA THREAD FILETAGE	MICRAS µ	€	REFERENCIA PART NO. RÉFÉRENCE			ROSCA THREAD FILETAGE	MICRAS µ	€	
FD110G06AB3DZ4	1/2	6	455,08	D1-10-G06A	A	B	C	1/2-3/4	6	35,38
FD110G06AB4DZ4	3/4	6	455,08		45	25,4	86			
FD110G10AB3DZ4	1/2	10	455,08	D1-10-G10A	45	25,4	86	1/2-3/4	10	35,38
FD110G10AB4DZ4	3/4	10	455,08							
FD130G06AB4DZ4	3/4	6	574,12	D1-30-G06A	53	28	120	3/4-1	6	58,13
FD130G06AB5DZ4	1	6	574,12							
FD130G10AB4DZ4	3/4	10	574,12	D1-30-G10A	53	28	120	1	10	58,02
FD130G10AB5DZ4	1	10	574,12							

Filtro en Línea (Carcasas)

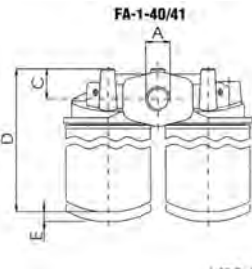
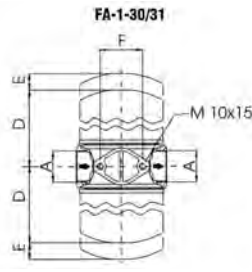
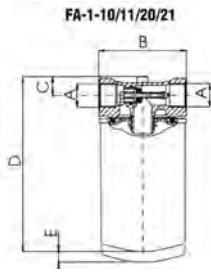

Line Filter Grid

Tête Filtre pour Cartouche Vissable Spin-on

REFERENCIA ASPIRACIÓN PART NO. A RÉFÉRENCE A	REFERENCIA RETORNO PART NO. R RÉFÉRENCE R	ROSCA THREAD FILETAGE	€	CARTUCHO CARTRIDGE CARTOUCHE
FA-1-10/11-A	FA-1-10/11-R	3/4	27,04	SPA-1-10 SPA-1-11
FA-1-20/21-A	FA-1-20/21-R	1 1/4	39,01	SPA-1-20 SPA-1-21
FA-1-30/31-A	FA-1-30/31-R	1 1/2 doble vertical	100,43	SPA-1-20 SPA-1-21
FA-1-40/41-A	FA-1-40/41-R	1 1/2 doble horizontal	354,38	SPA-1-20 SPA-1-21

Cartucho

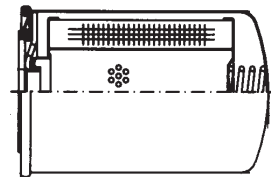

Cartridge

Cartouche Vissable spin-on

REFERENCIA PART NO. RÉFÉRENCE		REFERENCIA PART NO. RÉFÉRENCE		REFERENCIA PART NO. RÉFÉRENCE		REFERENCIA PART NO. RÉFÉRENCE	
CARTÓN 10µ CARBOARD 10µ CARTON 10µ	€	CARTÓN 25µ CARBOARD 25µ CARTON 25µ	€	METALICO 60µ METALLIC 60µ MÉTALLIQUE 60µ	€	METALICO 125µ METALLIC 125µ MÉTALLIQUE 125µ	€
SPA-1-10-C10	17,42	SPA-1-10-C25	17,42	SPA-1-10-T60	42,49	SPA-1-10-T125	34,11
SPA-1-11-C10	24,14	SPA-1-11-C25	24,14	SPA-1-11-T60	59,87	SPA-1-11-T125	51,76
SPA-1-20-C10	28,58	SPA-1-20-C25	28,58	SPA-1-20-T60	78,95	SPA-1-20-T125	62,96
SPA-1-21-C10	42,49	SPA-1-21-C25	42,49	SPA-1-21-T60	91,35	SPA-1-21-T125	77,52

Para la carcasa FA 1-30/31, 1-40/41, se colocarán dos cartuchos.

For grid FA1-30/31, 1-40/41, it will place 2 cartridges.

Les têtes FA1-30/31, 1-40/41, sont avec 2 cartouches.

La válvula by-pass viene incluida. Los manómetros o vacuómetros bajo pedido. Para filtración de mayor o menor micraje, consultar.

The by-pass valve is included. Pressure and vacuum gauges, on order. For > or < filtration, please, enquire us.

Toutes les têtes sont avec by-pass. Les manomètres ou vacuumètres sur demande. Pour ± filtration (µ), sur demande.

FILTRO DE RETORNO SUMERGIDO EN DEPÓSITO
SUBMERGED RETURN FILTER
FILTRE SEMI-IMMERGE RETOUR



Cabeza



Submerged Return Filter Grid

Tête Filtre Semi-Immergé Retour

REFERENCIA PART NO. RÉFÉRENCE	ROSCA THREAD FILETAGE	€	CARTUCHO CARTRIDGE CARTOUCHE
FR1-10	1/2	30,75	R-1-10
FR1-20	1/2	38,05	R-1-20
FR1-21	3/4	42,22	R-1-20
FR1-22	3/4	37,08	R-1-22
FR1-23	1	39,98	R-1-22
FR1-40	1	84,20	R-1-40
FR1-41	1 1/4	82,12	R-1-40
FR1-50	1 1/4	142,72	R-1-50
FR1-51	1 1/2	153,92	R-1-51
FR1-52	1 1/2	139,13	R-1-50
FR1-60	1 1/2	154,11	R-1-60
FR1-61	2	149,98	R-1-60
FR1-64	2	165,70	R-1-64

Cartucho

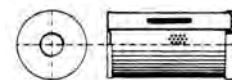

Submerged Return Filter Cartridge

Cartouche de Filtre Semi-immérgé

REFERENCIA PART NO. RÉFÉRENCE		REFERENCIA PART NO. RÉFÉRENCE		REFERENCIA PART NO. RÉFÉRENCE		REFERENCIA PART NO. RÉFÉRENCE	
CARTÓN 10µ CARDBOARD 10µ CARTON 10µ	€	CARTÓN 25µ CARDBOARD 25µ CARTON 25µ	€	METALICO 60µ METALLIC 60µ MÉTALLIQUE 60µ	€	METALICO 125µ METALLIC 125µ MÉTALLIQUE 125µ	€
R-1-10-C10-B	8,96	R-1-10-C25-B	8,96	R-1-10-T60-B	12,01	R-1-10-T125-B	11,16
R-1-20-C10-B	10,47	R-1-20-C25-B	10,47	R-1-20-T60-B	17,15	R-1-20-T125-B	15,45
R-1-22-C10-B	11,67	R-1-22-C25-B	11,67	R-1-22-T60-B	19,20	R-1-22-T125-B	17,96
R-1-40-C10-B	17,61	R-1-40-C25-B	17,61	R-1-40-T60-B	41,95	R-1-40-T125-B	32,45
R-1-50-C10-B	20,12	R-1-50-C25-B	20,12	R-1-50-T60-B	47,90	R-1-50-T125-B	37,70
R-1-51-C10-B	22,63	R-1-51-C25-B	22,63	R-1-51-T60-B	58,17	R-1-51-T125-B	42,80
R-1-60-C10-B	22,63	R-1-60-C25-B	22,63	R-1-60-T60-B	58,17	R-1-60-T125-B	42,80
R-1-64-C10-B	30,21	R-1-64-C25-B	30,21	R-1-64-T60-B	77,87	R-1-64-T125-B	55,62
R-1-65-C10-B	52,17	R-1-65-C25-B	51,18	R-1-65-T60-B	96,99	R-1-65-T125-B	65,89

FILTRO DE RETORNO SUMERGIDO EN DEPÓSITO
SUBMERGED RETURN FILTER
FILTRE SEMI-IMMERGE RETOUR

19

DEPÓSITOS

BOMBAS Y
DIVISORES

MOTORES
ELÉCTRICOS

VÁLVULAS

DISTRIBUIDORES

ELECTROVÁLVULAS

EMPUÑADURAS

ACUMULADORES

CILINDROS

VARIOS

Medidas de Cartuchos de Filtros de Retorno					
<i>Cartridge</i>					
<i>Cartouche Filtre Semi-Immerge</i>					
TIPO DE FILTRO KIND OF FILTER TYPE DE FILTRE	D	d	L	l	l1
R110C10B	50	25	76	70	6
R110G25B	50	25	76	70	6
R120C10B	70	29	86	80	6
R120C25B	70	29	86	80	6
R122C10B	70	29	136	130	6
R122C25B	70	29	136	130	6
R122T60B	70	29	136	130	6
R122T125B	70	29	136	130	6
R140C25B	99	41	214	206	9
R140T60B	99	41	214	206	9
R140T125B	99	41	214	206	9
R142C25B	99	41	179	170	9
R150C10B	130	51	150	141	9
R150C25B	130	51	150	141	9
R150T60B	130	51	150	141	9
R151C10B	130	52	209	200	9
R151C25B	130	52	209	200	9
R151T60B	130	52	209	200	9
R160C25B	130	65	209	200	9
R160T60B	130	65	209	200	9
R164C25B	130	65	259	250	9
R164T60B	130	65	259	250	9
R165C25B	130	65	280	271	9

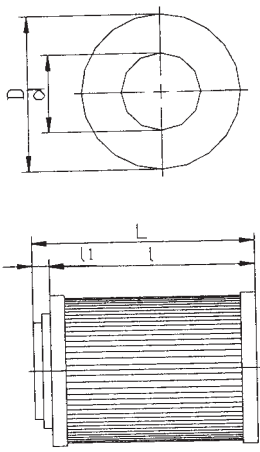

Cartuchos polivalentes en muchas marcas del mercado/Multi-faceted cartridges for a lot of market marks/ Cartouches polyvalentes pour plusieurs marques

ACCESORIOS PARA FILTROS/ACCESORIES FOR FILTERS/ACCESOIRES POUR FILTRES

Manómetro de colores*			
<i>Colours Pressure Gauge</i>			
<i>Manomètre à couleurs</i>			
REFERENCIA PART NO. RÉFÉRENCE	ROSCA THREAD FILETAGE	ESCALA LECTURE BAR/PSI	€
MFI CO 06	1/8	de 0 a 6	**

* Para filtros / For filters / Pour filtres

** Ver página 99 de Tarifa Conducciones

**See page 99 of Conductions Price List

**Voir page 99 du Tarif de Connectique

Vacuómetro de colores*			
<i>Colours Vacuum Gauge</i>			
<i>Vacuomètre à couleurs</i>			
REFERENCIA PART NO. RÉFÉRENCE	ROSCA THREAD FILETAGE	ESCALA LECTURE BAR/PSI	€
MFI VA 01	1/8	de -1 a 0	**

** Ver página 100 de Tarifa Conducciones

**See page 100 of Conductions Price List

**Voir page 100 du Tarif de Connectique

CAMPANAS Y ACOPLAMIENTOS
BELLHOUSINGS AND COUPLINGS
LANTERNES ET ACCOUPLEMENTS

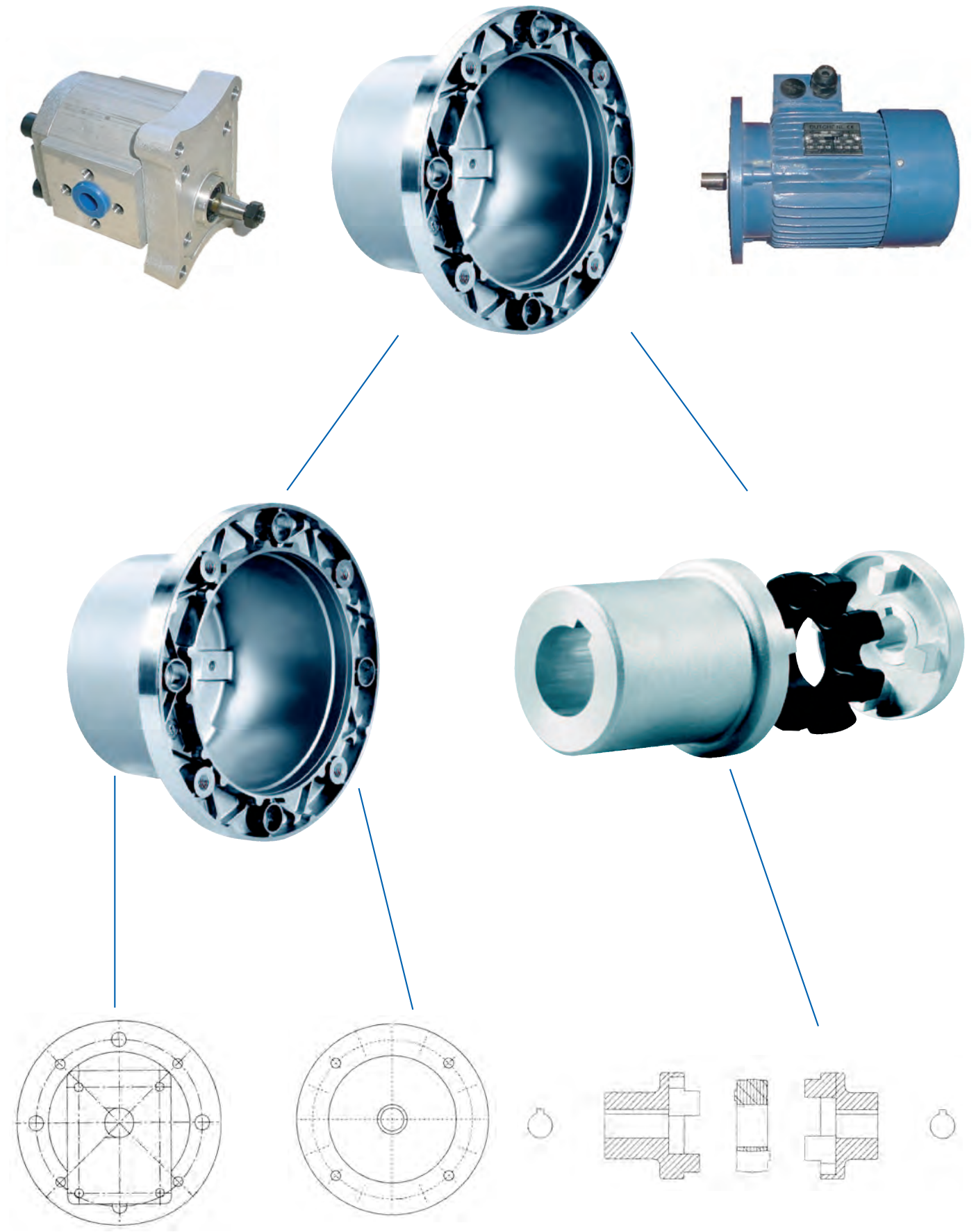

CAMPANAS Y ACOPLAMIENTOS
BELLHOUSINGS AND COUPLINGS
LANTERNES ET ACCOUPLEMENTS

DEPÓSITOS

BOMBAS Y
DIVISORESMOTORES
ELÉCTRICOS

VÁLVULAS

DISTRIBUIDORES

ELECTROVÁLVULAS

EMPUÑADURAS

ACUMULADORES

CILINDROS

VARIOS

Campanas Formato Europeo				
<i>Bell housings European Format</i>				
<i>Lanternes</i>				
REFERENCIA PART NO RÉFÉRENCE	GRUPO/GROUP/GROUPE BOMBA/PUMP/POMPE	PARA MOTOR FOR MOTOR POUR MOTEUR	Ø CAMPANA Ø BELLHOUSINGS Ø LANterne mm	€
LS161	F.1	De 0,3 a 0,5CV	160	21,95
LS201	F.1	De 0,75 a 2CV	200	24,46
LS250	F.1	De 3 a 5,5CV	250	35,13
LS203	F.2	De 0,75 a 2CV	200	26,14
LS252	F.2	De 3 a 5,5CV	250	35,13
LS300	F.2	De 7,5 a 12,5CV	300	60,01
L3511	F.2	De 15 a 30CV	350	121,90
LS255	F.3	De 3 a 5,5CV	250	38,06
LS302	F.3	De 7,5 a 12,5CV	300	60,01
L3513	F.3	De 15 a 30CV	350	121,90
LS306	F.3,5	De 7,5 a 12,5CV	300	61,69
L3507	F.3,5	De 15 a 30CV	350	172,71
L4006	F.3,5	40CV	400	216,20

Acoplamiento Formato Europeo*					
<i>European Format Coupling</i>					
<i>Accouplements Élastique Européen</i>					
REFERENCIA PART NO RÉFÉRENCE	GRUPO/GROUP/GROUPE BOMBA/PUMP/POMPE	REF. ESTRELLA SPIDERS PART. NO. RÉFÉRENCE ÉTOILES	PARA MOTOR FOR MOTOR POUR MOTEUR	Ø EJE MOTOR Ø AXE MOTIVE Ø ARBRE MOTEUR	€
ND3	F.1	5157030000	De 0,16 a 0,25CV	11	15,75
ND2	F.1	5157030000	De 0,33 a 0,5CV	14	15,75
ND5	F.1	5157030000	De 0,75 a 1CV	19	17,22
ND8	F.1	5157040000	De 1,5 a 2CV	24	23,54
ND11	F.1	5157040000	De 3 a 5,5CV	28	25,84
ND7	F.2	5157040000	De 0,75 a 1CV	19	23,33
ND10	F.2	5157040000	De 1,5 a 2CV	24	23,54
ND13	F.2	5157040000	De 3 a 5,5CV	28	25,84
ND16	F.2	5157050000	De 7,5 a 12,5CV	38	51,48
ND43A	F.2	5157060000	De 15 a 20CV	42	89,05
ND15	F.3	5157050000	De 3 a 5,5CV	28	41,19
ND17	F.3	5157050000	De 7,5 a 12,5CV	38	51,48
ND43C	F.3	5157060000	De 15 a 20CV	42	89,05
ND44C	F.3	5157060000	De 25 a 30CV	48	118,48
ND18C	F.3,5	5157060000	De 7,5 a 12,5CV	38	72,06
ND21A	F.3,5	5157060000	De 15 a 20CV	42	95,60
ND25A	F.3,5	5157060000	De 25 a 30CV	48	100,65
ND41A	F.3,5	5157060000	De 31 a 40CV	55	108,19

* Estrella elástica: NBR 75 Shores

* Elastic Star: NRB 75 SL

* Matière roue élastique: Acryle Nitrile Butadiene Noir 75 Shores NBR

Estrellas		
<i>Spiders</i>		
<i>Étoiles</i>		
REFERENCIA PART NO. RÉFÉRENCE	DESCRIPCION DESCRIPTION DESCRIPTION	€
5157030000	ESTRELLA GOMA Ø ext.42 mm (R42)	1,18
5157040000	ESTRELLA GOMA Ø ext.59 mm (R62)	2,21
5157050000	ESTRELLA GOMA Ø ext.79 mm (R82)	9,17
5157060000	ESTRELLA GOMA Ø ext.99 mm (R103)	9,21

Solicite nuestro catálogo técnico/Demandez notre catalogue technique/Enquire us our technical catalogue

MANÓMETROS PRESSURE GAUGES MANOMÈTRES

Manómetro DN 63 con baño de glicerina MG1-INOX 63- VERTICALES			
<i>Vertical Manometer DN 63 with Glycerin</i>			
<i>Manomètre DN 63-MG1 Glicerine Boîtier Inox Sortie Verticale</i>			
ROSCA THREAD FILETAGE	ESCALA SCALE LECTURE bar/psi	REFERENCIA PART NO. RÉFÉRENCE	€
G1/4B	0-1	MFI6304001V	*
G1/4B	0-4	MFI6304004V	*
G1/4B	0-6	MFI6304006V	*
G1/4B	0-10	MFI6304010V	*
G1/4B	0-12	MFI6304012V	*
G1/4B	0-16	MFI6304016V	*
G1/4B	0-20	MFI6304020V	*
G1/4B	0-25	MFI6304025V	*
G1/4B	0-40	MFI6304040V	*
G1/4B	0-60	MFI6304060V	*
G1/4B	0-100	MFI6304100V	*
G1/4B	0-160	MFI6304160V	*
G1/4B	0-2.5	MFI63042.5V	*
G1/4B	0-250	MFI6304250V	*
G1/4B	0-315	MFI6304315	*
G1/4B	0-400	MFI6304400V	*
G1/4B	0-600	MFI6304600V	*

Manómetro DN 63 con baño de glicerina MG3B-INOX 63- DORSALES			
<i>Dorsal Manometer DN 63 with Glycerin</i>			
<i>Manomètre DN 63-MG3B Glicerine Boîtier Inox Sortie Arrière</i>			
ROSCA THREAD FILETAGE	ESCALA SCALE LECTURE bar/psi	REFERENCIA PART NO. RÉFÉRENCE	€
G1/4B	0-1	MFI6304001-DB	*
G1/4B	0-2,5	MFI63042.5-DB	*
G1/4B	0-4	MFI6304004-DB	*
G1/4B	0-6	MFI6304006-DB	*
G1/4B	0-10	MFI6304010-DB	*
G1/4B	0-12	MFI6304012-DB	*
G1/4B	0-16	MFI6304016-DB	*
G1/4B	0-20	MFI6304020-DB	*
G1/4B	0-25	MFI6304025-DB	*
G1/4B	0-40	MFI6304040-DB	*
G1/4B	0-60	MFI6304060-DB	*
G1/4B	0-100	MFI6304100-DB	*
G1/4B	0-160	MFI6304160-DB	*
G1/4B	0-250	MFI6304250-DB	*
G1/4B	0-315	MFI6304315-DB	*
G1/4B	0-400	MFI6304400-DB	*
G1/4B	0-600	MFI6304600-DB	*

Manómetro DN 100 radial con baño de glicerina MG1-INOX 100- VERTICALES			
<i>Vertical Manometer DN 100 with Glycerin</i>			
<i>Manomètre DN 100-MG1 Glicerine Boîtier Inox Sortie Verticale</i>			
ROSCA THREAD FILETAGE	ESCALA SCALE LECTURE bar/psi	REFERENCIA PART NO. RÉFÉRENCE	€
G1/2B	0-1	MFI10008001V	*
G1/2B	0-4	MFI10008004V	*
G1/2B	0-6	MFI10008006V	*
G1/2B	0-10	MFI10008010V	*
G1/2B	0-12	MFI10008012V	*
G1/2B	0-16	MFI10008016V	*
G1/2B	0-20	MFI10008020V	*
G1/2B	0-25	MFI10008025V	*
G1/2B	0-40	MFI10008040V	*
G1/2B	0-60	MFI10008060V	*
G1/2B	0-100	MFI10008100V	*
G1/2B	0-160	MFI10008160V	*
G1/2B	0-250	MFI10008250V	*
G1/2B	0-315	MFI10008315V	*
G1/2B	0-400	MFI10008400V	*
G1/2B	0-600	MFI10008600V	*

Manómetro DN 100 radial con baño de glicerina MG3B-INOX 100- DORSALES			
<i>Dorsal Manometer DN 100 with Glycerin</i>			
<i>Manomètre DN 100-MG3B Glicerine Boîtier Inox Sortie Arrière</i>			
ROSCA THREAD FILETAGE	ESCALA SCALE LECTURE bar/psi	REFERENCIA PART NO. RÉFÉRENCE	€
G1/2B	0-1	MFI10008001-DB	*
G1/2B	0-2.5	MFI100082.5-DB	*
G1/2B	0-4	MFI10008004-DB	*
G1/2B	0-6	MFI10008006-DB	*
G1/2B	0-10	MFI10008010-DB	*
G1/2B	0-16	MFI10008016-DB	*
G1/2B	0-25	MFI10008025-DB	*
G1/2B	0-40	MFI10008040-DB	*
G1/2B	0-60	MFI10008060-DB	*
G1/2B	0-100	MFI10008100-DB	*
G1/2B	0-160	MFI10008160-DB	*
G1/2B	0-250	MFI10008250-DB	*
G1/2B	0-315	MFI10008315-DB	*
G1/2B	0-400	MFI10008400-DB	*
G1/2B	0-600	MFI10008600-DB	*

* Ver página 99 de Tarifa Conducciones

See page 99 of Conductions Price List

Voir page 99 du Tarif de Connectique

MALETINES COMPLETOS CON LATIGUILLO
COMPLET KIT WITH FLEXIBLE ASSEMBLY
COFFRE MANOMÈTRES



CAUDALÍMETROS / FLOW GAUGES / DEBITMÈTRES



TOMAS DE MANÓMETROS
MANOMETERS FITTINGS
FLEXIBLE POUR PRISE DE PRESSION



Ver páginas 89 a 103 de n/catálogo de flexibles
 See page 89 to 103 of flexibles price list
Voir pages 89 à 103 du catalogue Flexibles

MÁQUINAS TRATAMIENTO TUBO FLEXIBLE
MACHINES FOR MOUNTING FLEXIBLES
MACHINES POUR LE MONTAGE DES FLEXIBLES

▶ **PE 32 1" 1/4 6 SP)**



☀ 207 t ⚙ +38 mm ➡ 118 mm

▶ **PE 58 (2" 6 SP)**



☀ 305 t ⚙ +54 mm ➡ 180 mm

▶ **SPEBDEG**



▶ **CHM2-20D (1" 1/4)**



Ø Disco-250mm
 Pot. Motor 2,2 KW

▶ **CHM4-32D (2")**



▶ **PBC-32**



▶ **Portarrollos | Porte-Rouleaux**
 Roll-Holder | Portarrotoli



▶ **Banco de pruebas BE 1500 / BE 2500 | Banque d'essais BE 1500 / BE 2500**
 Testing bank BE 1500 / BE 2500 | Banco de prova BE 1500 / BE 2500



Opcional | Optionnel |
 Optional | Opzionale